



**MARTINI**<sup>®</sup>  
*Costruzioni Nautiche*



*a sea of emotion*



**MARTINI**<sup>®</sup>  
*Costruzioni Nautiche*



# Tradizione e Innovazione

## *Tradition and Innovation*



 Martini Costruzioni Nautiche è un'azienda familiare, esempio del famoso artigianato italiano. Fu fondata da mio padre quasi mezzo secolo fa e da allora portiamo avanti la filosofia del lavoro fatto a mano e del design Made in Italy.

La linea SUNNY® viene prodotta interamente nel nostro stabilimento. Seguiamo il processo produttivo in tutte le fasi, mettendo a frutto la nostra esperienza e la nostra creatività.

Questa particolare cura del dettaglio rende i nostri natanti unici e di altissima qualità. Il nostro è un prodotto resistente, sicuro e di design.

 Martini Costruzioni Nautiche is a family-owned company and is an example of fine Italian craftsmanship. My father founded it almost half a century ago and since then we've been keeping with our philosophy of creating handmade Italian design products.

The SUNNY® line is entirely produced in our workshop. We oversee directly all the steps of production making the most of our experience and creativity. Our careful attention to detail makes our boats unique and of the highest quality. Our product is resistant, safe and stylish.



Fondatore della Martini Costruzioni Nautiche.  
Ireneo Martini (foto d'epoca)

 Martini Costruzioni Nautiche est une entreprise familiale qui représente encore la célèbre tradition artisanale italienne. Elle a été fondée par mon père, il y a environ un demi-siècle. Notre philosophie est toujours la même : le travail est fait à la main, le produit est conçu et fabriqué en Italie. La ligne SUNNY® est entièrement produite dans notre usine. On suit toutes les phases de la production, en mettant en valeur notre expérience et notre créativité. Cette attention spéciale pour les détails rend nos embarcations uniques et d'une très grande qualité. Notre produit est résistant, sûr et élégant.

 Innovation aus Tradition Die Martini Costruzioni Nautiche ist ein Familienunternehmen und Ausdruck des italienischen Handwerks. Das Unternehmen wurde vor fast einem halben Jahrhundert von meinen Vater gegründet und seit dem führen wir die Tradition des Handwerks und des Made in Italy Design fort. Die Produktion der Serie "Sunny" erfolgt komplett in unserer Werkstatt, wo wir jeden einzelnen Schritt pflegen und unsere Erfahrung und Kreativität einsetzen. Dank dieser Liebe zum Detail sind unsere Boote unvergleichlich und aus bester Qualität. Unser Endprodukt ist strapazierfähig, sicher und stilvoll.

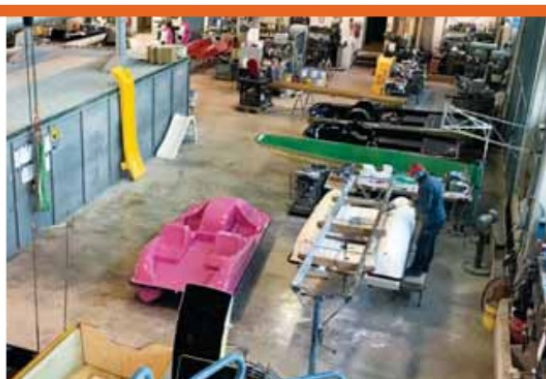



Qualità e sicurezza garantite da mezzo secolo di attività

*Quality and safety are granted since half a century*

 Qualità e sicurezza garantite da mezzo secolo di attività

Un binomio che vale sia per i nostri prodotti, sia per gli ambienti di lavoro che rispettano gli standard imposti e la natura. Utilizziamo materie riciclabili ed ecologiche e ci sottoponiamo a verifiche periodiche.

 Almost half a century of top quality and safety. Quality and safety are at the heart of what we do. Both our product and our workplace comply with all the safety and environmental standards.

We use recyclable and ecological materials and do run periodical tests.

 Qualité et sécurité

Un binôme qui caractérise nos produits, mais aussi le milieu de travail, chez Martini on respecte les standards de sécurité mais aussi la nature. On utilise des matériaux recyclables et écologiques et on est soumis à des contrôles périodiques.

 Qualität und Sicherheit

Beides gilt für unsere Produkte, sowohl als auch für den Arbeitsplatz, die die vorgegebenen Standards und die Natur berücksichtigen. Wir benutzen wiederverwertbare und umweltfreundliche Materialien und führen regelmäßige Tests durch.





# MARTINI il tuo mare di emozioni

## I nostri punti di forza sono:

- ★ Grande varietà di modelli per utilizzo commerciale e privato
- ★ Lavorazione artigianale
- ★ Design inconfondibile
- ★ 100% Made in Italy
- ★ Sicurezza
- ★ Garanzia 24 mesi

## Our strengths are:

- ★ A wide range of products, suitable for commercial and private use
- ★ Craftsmanship
- ★ Unique design
- ★ 100% Made in Italy
- ★ Safety
- ★ A 24 month guarantee

## Nos points de force sont:

- ★ Une grande variété de modèles pour utilisation commerciale et privée
- ★ Travail artisanal
- ★ Conception inimitable
- ★ 100% Produit en Italie
- ★ Sécurité
- ★ Garantie 24 mois

## Unsere Stärken sind:

- ★ Vielfalt der Modelle für den gewerblichen und privaten Gebrauch
- ★ Handwerkliche Bearbeitung
- ★ Unverwechselbares Design
- ★ 100% Made in Italy
- ★ Sicherheit
- ★ 24 Monate Garantie







## SUNNY® la famosa linea di natanti a pedali, con tanti modelli e accessori per tutte le esigenze

 I nostri modelli soddisfano tutte le esigenze e tutti i gusti. Ogni modello è personalizzabile grazie a una vasta gamma di accessori. Il cliente ha la possibilità di farsi confezionare il suo prodotto su misura.

Il criterio di qualità si evidenzia anche nell'attenzione per la sicurezza. Ogni natante ha al suo interno una riserva di galleggiamento a garantire l'inaffondabilità anche nel caso improbabile di rottura dello scafo. La robustezza e la resistenza che caratterizza i nostri natanti, li rendono ideali per l'utilizzo commerciale e il noleggio. Dove c'è acqua, c'è Martini!

 We have a variety of models to suit all needs and tastes. All our boats are customizable with our wide range of accessories. The client can choose how to configure his boat. Our focus on quality is also aimed at ensuring top notch safety. Each boat is equipped with a floating device that makes it unsinkable, even in case hull breaks. Our boats are suitable for commercial use and for rental, because they are solid and strong. Where there is water, there is Martini!

 Une grande variété de modèles pour tous les goûts et exigences. Chaque modèle est personnalisable grâce à une vaste gamme d'accessoires. Le client a la possibilité de demander la réalisation d'un produit sur mesure.

La qualité de nos produits passe aussi par la grande attention qu'on porte à la sécurité. Chaque embarcation affiche une réserve de flottaison pour assurer l'insubmersibilité même dans le cas improbable de rupture de la coque.

La solidité et la résistance, caractérisant nos embarcations, en font des produits idéaux pour l'utilisation commerciale et la location.

Là où il y a de l'eau, il y a Martini!

 Unsere Modelle erfüllen alle Bedürfnisse und jeden Geschmack. Dank des Zubehörs kann jedes Modell persönlich gestaltet werden. Das Produkt wird auf die Wünsche des Kunden angepasst.

Unsere Qualität spiegelt sich auch in der Aufmerksamkeit für die Sicherheit wieder. Jedes Boot ist mit Auftriebskörper ausgestattet und daher unsinkbar, auch im Falle eines Rumpfbrechens.

Robuste und strapazierfähige Boote die ideal für den gewerblichen Gebrauch und den Verleih sind.

Wasser ruft Martini!





**MARTINI**<sup>®</sup>  
*Costruzioni Nautiche*

*il tuo mare di emozioni*



# SUNNY H2O



Ultraresistente e riciclabile al 100%  
*Ultrastrong and 100% recyclable*



## OPTIONAL

- 04/B Scaletta/Ladder Basic
- 04/E Scaletta/Ladder Elite
- 06 Ruote/Wheels
- 07 Scivolo/Slide
- 11 Buffer
- 15 Telo di rimessaggio/Textile coverage

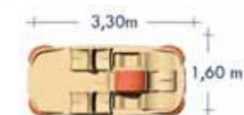
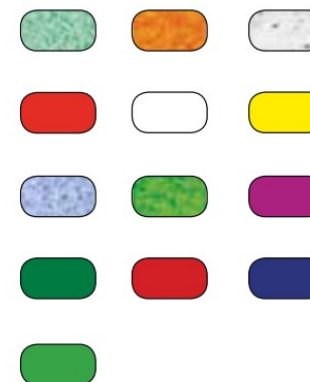

4 + = 300 kg WEIGHT 130 kg  
 MATERIAL: POLYETHYLENE



# SUNNY H2O PLUS



Ultrasensibile, riciclabile e ancora più grande  
*H2O Plus ultrastrong, recyclable and even bigger*



### OPTIONAL

- 04/B Scaletta/Ladder Basic
- 04/E Scaletta/Ladder Elite
- 06 Ruote/Wheels
- 07 Scivolo/Slide Maxi
- 11 Buffer
- 15 Telo di rimessaggio/Textile coverage

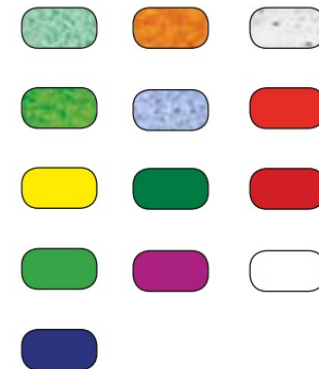

5 + = 375 kg WEIGHT 150 kg  
 MATERIAL: POLYETHYLENE

# SUNNY H2O SMART



## OPTIONAL

04/B Scaletta/Ladder Basic

04/E Scaletta/Ladder Elite

06 Ruote/Wheels

07 Scivolo/Slide

11 Buffer

15 Telo di rimessaggio/Textile coverage

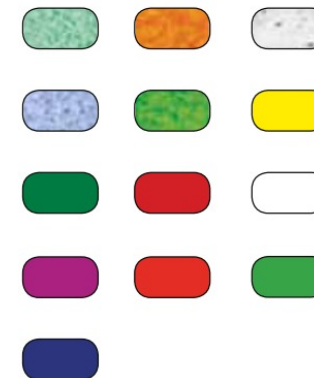

2 + 2 + = 225 kg WEIGHT 90 kg  
MATERIAL: POLYETHYLENE

# JOLIE



Il grande di casa Martini! C'è posto per tutti  
Family funboat. Bigger is better



## OPTIONAL

- 03 Protezione chiglia/Keel protection
- 04/Y Scaletta/Ladder Yacht
- 04/B Scaletta/Ladder Basic
- 04/E Scaletta/Ladder Elite
- 06/J Ruote d'alaggio mod. Jolie  
Haulage wheels mod. Jolie
- 09 Tettuccio parasole/Sun&rain shield
- 10 Trampolino/Spring board
- 11 Buffer
- 12/S Scivolo/Slide Superslider
- 15 Telo di rimessaggio  
Textile coverage

## DOTAZIONE DI SERIE STANDARD EQUIPMENT

- 05 Parabordo/Rubber fender

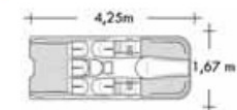
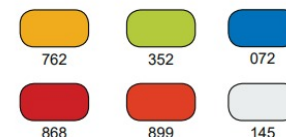

6 + = 450 kg WEIGHT 170 kg  
MATERIAL: FIBERGLASS

# SUNNY TIME 4



Un nuovo design per un classico senza tempo  
*A complete new design for our timeless piece*



## OPTIONAL

- 02 Pulpito/Bow pulpit
- 03 Protezione chiglia/Keel protection
- 04 Scaletta/Ladder Standard
- 04/Y Scaletta/Ladder Yacht
- 04/B Scaletta/Ladder Basic
- 04/E Scaletta/Ladder Elite
- 05 Parabordo/Rubber fender
- 06 Ruote/Wheels
- 07 Scivolo/Slide
- 09 Tettuccio parasole/Sun&rain shield
- 10 Trampolino/Spring board
- 12/B Scivolo/Slide Big slider
- 12/S Scivolo/Slide Superslider
- 13 Scivolo/Slide Bent-slider
- 15 Telo di rimessaggio/Textile coverage

## DOTAZIONE DI SERIE

### STANDARD EQUIPMENT

- 01 Maniglie tieniti bene/Handle



762



352



072



868



899



145

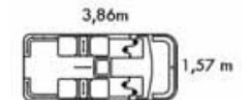

5 + = 375 kg WEIGHT 150 kg  
 MATERIAL: FIBERGLASS

# HAPPY HOUR



*Ogni ora è l'ora felice*  
*Every hour is happy hour*



## OPTIONAL

- 03 Protezione chiglia/Keel protection
- 04/B Scaletta/Ladder Basic
- 04/E Scaletta/Ladder Elite
- 06 Ruote/Wheels
- 09 Tettuccio parasole/Sun&rain shield
- 10 Trampolino/Spring board
- 11 Buffer
- 15 Telo di rimessaggio/Textile coverage
- Borsa Termica

## DOTAZIONE DI SERIE STANDARD EQUIPMENT

- 02 Pulpito/Bow pulpit
- 05 Parabordo/Rubber fender

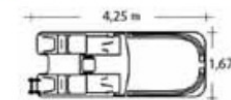
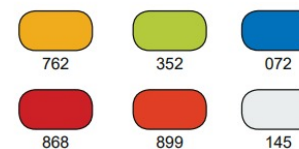

5 + = 450 kg WEIGHT 170 kg  
MATERIAL: FIBERGLASS

# SUNNY TIME S



Per chi non vuole perdere neanche un raggio di sole  
*For real sunlovers*



## OPTIONAL

- 02 Pulpito/Bow pulpit
- 03 Protezione chiglia/Keel protection
- 04 Scaletta/Ladder Standard
- 04/Y Scaletta/Ladder Yacht
- 04/B Scaletta/Ladder Basic
- 04/E Scaletta/Ladder Elite
- 05 Parabordo/Rubber fender
- 06 Ruote/Wheels
- 07 Scivolo/Slide
- 09 Tettuccio parasole/Sun&rain shield
- 10 Trampolino/Spring board
- 11 Buffet
- 12/B Scivolo/Slide Big slider
- 12/S Scivolo/Slide Superslider
- 13 Scivolo/Slide Bent-slider
- 15 Telo di rimessaggio/Textile coverage

## DOTAZIONE DI SERIE

### STANDARD EQUIPMENT

- 01 Maniglie tieniti bene/Handle

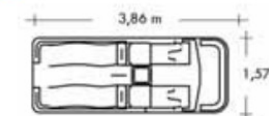
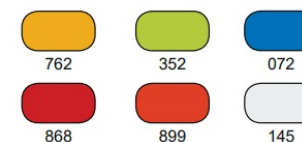

5 + = 375 kg WEIGHT 150 kg  
MATERIAL: FIBERGLASS

# SEABUGGY 405



Un mito inaffondabile  
*An unsinkable myth*

## OPTIONAL

- 03 Protezione chiglia/Keel protection
- 10 Trampolino/Spring board
- 11 Buffer
- 12/S Scivolo/Slide Superslider
- 15 Telo di rimessaggio/Textile coverage
- SB Capottina alluminio con tessuto  
Alu-sunshield with fabric

## DOTAZIONE DI SERIE STANDARD EQUIPMENT

- 04/E Scaletta/Ladder Elite
- 05 Parabordo/Rubber fender
- 06 Ruote/Wheels

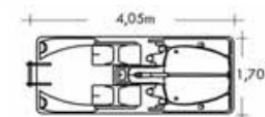
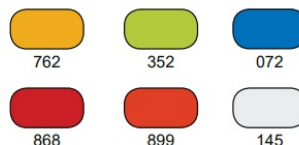

5 + = 400 kg WEIGHT 160 kg  
MATERIAL: FIBERGLASS

# SEABUGGY 330



Dimensioni compatte  
*Compact version*



## OPTIONAL

- 03 Protezione chiglia/Keel protection
- 04/B Scaletta/Ladder Basic
- 04/E Scaletta/Ladder Elite
- 05 Parabordo/Rubber fender
- 06 Ruote/Wheels
- 07 Scivolo/Slide
- 10 Trampolino/Spring board
- 11 Buffer
- 15 Telo di rimessaggio/Textile coverage
- SB Capottina alluminio con tessuto  
Alu-sunshield with fabric

## DOTAZIONE DI SERIE STANDARD EQUIPMENT

- 04/Y Scaletta/Ladder Yacht
- 05 Parabordo/Rubber fender

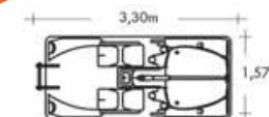
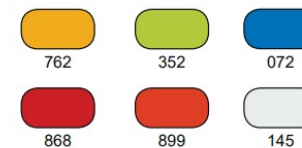

4 + = 300 kg WEIGHT 140 kg  
MATERIAL: FIBERGLASS



# CIGNO



Divertimento Bestiale  
Beastly Fun

### OPTIONAL

- 03 Protezione chiglia/Keel protection
- 04/Y Scaletta/Ladder Yacht
- 04/B Scaletta/Ladder Basic
- 04/E Scaletta/Ladder Elite
- 06 Ruote / Wheels
- 07 Scivolo/Slide
- 11 Buffer

### DOTAZIONE DI SERIE STANDARD EQUIPMENT

- 05 Parabordo/Rubber fender

 Siamo partiti dal nostro campione di vendite e gli abbiamo conferito un look bestiale. La garanzia Martini Nautica si conferma in nuova veste. Corpo interamente rielaborato, forme armoniose e un elegante collo. Spazio ideale per la famiglia o un gruppo di amici. Il divertimento sull'acqua è garantito. Il design si rinnova, conservando tutte le caratteristiche di robustezza, sicurezza e agilità. Disponibile nel colore bianco.

 We gave our all-time bestseller a beastly look. One of Martini's highest-quality creations comes in a new version. The body has been entirely reworked and now has new harmonious shapes and an elegant swan neck. It's perfect for having fun in the water with your family or a group of friends! The design is brand new while the boat's safety, sturdiness and agility remain unchanged. Available in white.

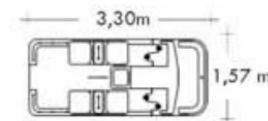

4  +  = 300 kg WEIGHT 145 kg  
MATERIAL: FIBERGLASS

17

# FLAMINGO



## OPTIONAL

- 03 Protezione chiglia/Keel protection
- 04/Y Scaletta/Ladder Yacht
- 04/B Scaletta/Ladder Basic
- 04/E Scaletta/Ladder Elite
- 06 Ruote / Wheels
- 07 Scivolo/Slide
- 11 Buffer

## DOTAZIONE DI SERIE STANDARD EQUIPMENT

- 05 Parabordo/Rubber fender

Essere Rosa  
*Be Pink*

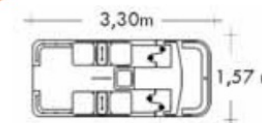

4 + = 300 kg WEIGHT 145 kg  
MATERIAL: FIBERGLASS

# UNICORNO



Momenti Magici  
*Magic Moments*



## OPTIONAL

- 03 Protezione chiglia/Keel protection
- 04/Y Scaletta/Ladder Yacht
- 04/B Scaletta/Ladder Basic
- 04/E Scaletta/Ladder Elite
- 06 Ruote / Wheels
- 07 Scivolo/Slide
- 11 Buffer

## DOTAZIONE DI SERIE STANDARD EQUIPMENT

- 05 Parabordo/Rubber fender

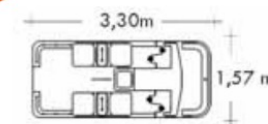

4 + = 300 kg WEIGHT 145 kg  
MATERIAL: FIBERGLASS

# ANATRA



## OPTIONAL

- 03 Protezione chiglia/Keel protection
- 04/Y Scaletta/Ladder Yacht
- 04/B Scaletta/Ladder Basic
- 04/E Scaletta/Ladder Elite
- 06 Ruote/Wheels
- 07 Scivolo/Slider
- 11 Buffer

## DOTAZIONE DI SERIE STANDARD EQUIPMENT

- 05 Parabordo/Rubber fender

◀ Lucky Duck

◀ Duckling

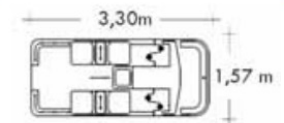

4 + = 300 kg WEIGHT 145 kg  
MATERIAL: FIBERGLASS

# SUNNYTIME 330



Piccoli, ma davvero grandi!  
*Small in size, big in attitude!*

## OPTIONAL

- 02 Pulpito/Bow pulpit
- 03 Protezione chiglia/Keel protection
- 04 Scaletta standard/Standard Ladder
- 04/Y Scaletta/Ladder Yacht
- 04/B Scaletta/Ladder Basic
- 04/E Scaletta/Ladder Elite
- 05 Parabordo/Rubber fender
- 06 Ruote/Wheels
- 07 Scivolo/Slide
- 09 Tettuccio parasole/Sun&rain shield
- 10 Trampolino/Spring board
- 11 Buffer
- 15 Telo di rimessaggio/Textile coverage

## DOTAZIONE DI SERIE STANDARD EQUIPMENT

- 01 Maniglie tieniti bene/Handle

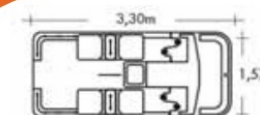
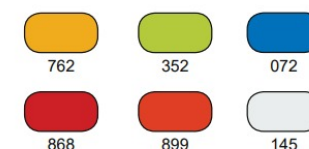

4 + = 300 kg WEIGHT 120 kg  
MATERIAL: FIBERGLASS

# SUNNY MOUSE



Il piccolo di casa, ma con tanto appeal  
*Small, but really great*



## OPTIONAL

- 05 Parabordo/Rubber fender
- 11 Buffer
- 15 Telo di rimessaggio/Textile coverage

## DOTAZIONE DI SERIE STANDARD EQUIPMENT

- 01 Maniglie tieniti bene/Handle
- 03 Protezione chiglia/Keel protection
- 04/Y Scaletta/Ladder Yacht
- 06 Ruote/Wheels

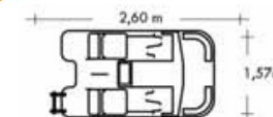
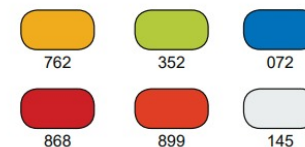

3 + = 225 kg WEIGHT 100 kg  
MATERIAL: FIBERGLASS

# SUNNY R



Ideale per prendere il sole  
*Ideal for sunbathing*



## OPTIONAL

- 03 Protezione chiglia/Keel protection
- 04/B Scaletta/Ladder Basic
- 04/E Scaletta/Ladder Elite
- 05 Parabordo/Rubber fender
- 06 Ruote/Wheels
- 07 Scivolo/Slide
- 09 Tettuccio parasole/Sun&rain shield
- 10 Trampolino/Spring board
- 11 Buffer
- 12/B Scivolo/Slide Big slider
- 15 Telo di rimessaggio/Textile coverage

## DOTAZIONE DI SERIE

### STANDARD EQUIPMENT

- 01 Maniglie tieniti bene/Handle
- 02 Pulpito/Bow pulpit
- 04/Y Scaletta/Ladder Yacht

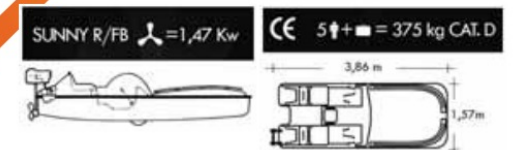
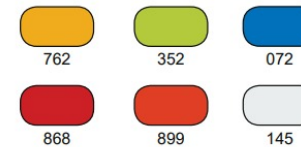

5 + = 375 kg WEIGHT 150 kg  
MATERIAL: FIBERGLASS

# SUNNY R COMFORT



Con tutti i comfort  
Even more comfort

## OPTIONAL

- 03 Protezione chiglia/Keel protection
- 04/B Scaletta/Ladder Basic
- 04/E Scaletta/Ladder Elite
- 05 Parabordo/Rubber fender
- 06 Ruote/Wheels
- 09 Tettuccio parasole/Sun&rain shield
- 10 Trampolino/Spring board
- 11 Buffer
- 15 Telo di rimessaggio/Textile coverage

## DOTAZIONE DI SERIE

### STANDARD EQUIPMENT

- 01 Maniglie tieniti bene/Handle
- 02 Pulpito/Bow pulpit
- 04/Y Scaletta/Ladder Yacht



762



352



072



868



899



145

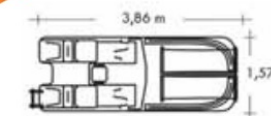

5 + = 375 kg WEIGHT 150 kg  
MATERIAL: FIBERGLASS



# SUNNY TIME



Con ampia piattaforma ideale per scivoli e trampolini  
*Big platform for slider and springboards*



## OPTIONAL

- 02 Pulpito/Bow pulpit
- 03 Protezione chiglia/Keel protection
- 04 Scaletta standard/Standard Ladder
- 04/Y Scaletta/Ladder Yacht
- 04/B Scaletta/Ladder Basic
- 04/E Scaletta/Ladder Elite
- 05 Parabordo/Rubber fender
- 06 Ruote/Wheels
- 07 Scivolo/Slide
- 09 Tettuccio parasole/Sun&rain shield
- 10 Trampolino/Spring board
- 11 Buffer
- 12/B Scivolo/Slide Big slider
- 12/S Scivolo/Slide Superslider
- 13 Scivolo/Bent Slider
- 15 Telo di rimessaggio/Textile coverage

## DOTAZIONE DI SERIE STANDARD EQUIPMENT

- 01 Maniglie tieniti bene/Handle

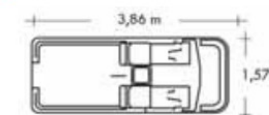
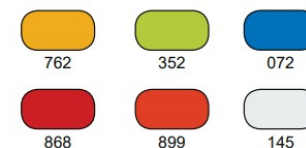

5 + = 375 kg WEIGHT 150 kg  
 MATERIAL: FIBERGLASS

# SUNNY TIME SPECIAL



Ideale per escursioni di gruppo  
*Ideal for group trips*



## OPTIONAL

- 02 Pulpito/Bow pulpit
- 03 Protezione chiglia/Keel protection
- 04 Scaletta standard/Standard Ladder
- 04/Y Scaletta/Ladder Yacht
- 04/B Scaletta/Ladder Basic
- 04/E Scaletta/Ladder Elite
- 05 Parabordo/Rubber fender
- 06 Ruote/Wheels
- 07 Scivolo/Slide
- 09 Tettuccio parasole/Sun&rain shield
- 10 Trampolino/Spring board
- 11 Buffer
- 12/B Scivolo/Slide Big slider
- 12/S Scivolo/Slide Superslider
- 13 Scivolo/Bent Slide
- 15 Telo di rimessaggio/Textile coverage

## DOTAZIONE DI SERIE

### STANDARD EQUIPMENT

- 01 Maniglie tieniti bene/Handle

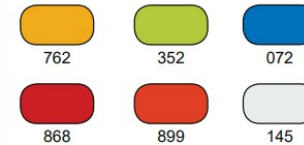

5 + = 375 kg WEIGHT 150 kg



MATERIAL: FIBERGLASS

# SUNNY SPEEDY 4





**OPTIONAL**

- 03 Protezione chiglia/Keel protection
- 15 Telo di rimessaggio/Textile coverage

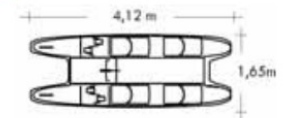
		
762	352	072
		
868	899	145



4  +  = 300 kg WEIGHT 130 kg  
MATERIAL: FIBERGLASS

# SUNNY SPEEDY



Un lungo piacere - veloce e leggero per percorrere distanze  
*Fast and slim - for long distances*

## OPTIONAL

- 03 Protezione chiglia/Keel protection
- 15 Telo di rimessaggio/Textile coverage



762



352



072



868



899



145

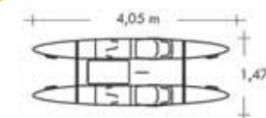

2 + = 200 kg WEIGHT 100 kg  
 MATERIAL: FIBERGLASS

# SUNNY SPEEDY + MANOLO'



Il dispositivo per la "pedalata manuale" brevettato. Divertimento, sport e tempo libero accessibili a tutti.  
*Our patented device for "manual pedaling". Fun, sports and leisure for really everyone.*



## OPTIONAL

03 Protezione chiglia/Keel protection

15 Telo di rimessaggio/Textile coverage

 Il dispositivo per la "pedalata manuale" brevettato. Divertimento, sport e tempo libero accessibili a tutti.

Sport, divertimento e mare accessibili a tutti! Questo particolare dispositivo da noi brevettato permette di trasmettere la forza motrice anche o addirittura solo con le braccia. Perfetta per lo sport all'area aperta e per competizioni sportive!

 Our patented device for "hand pedaling". Fun and leisure accessible for everyone.

Making sports, fun and the sea accessible to everyone!

With our patented device, the boat can be also or exclusively arm – propelled. Perfect for outdoor sports and competitions!

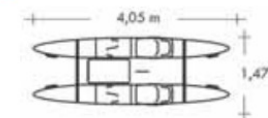

2  +  = 200 kg WEIGHT 100 kg

MATERIAL: FIBERGLASS

# PAGURO



5 posti e un design compatto e sicuro!  
*Compact and safe 5 seater!*



## OPTIONAL

- 03 Protezione chiglia/Keel protection
- 04/B Scaletta/Ladder Basic
- 04/E Scaletta/Ladder Elite
- 06 Ruote/Wheels
- 09 Tettuccio parasole/Sun&rain shield
- 10 Trampolino/Spring board
- 11 Buffer
- 15 Telo di rimessaggio/Textile coverage

## DOTAZIONE DI SERIE STANDARD EQUIPMENT

- 04/Y Scaletta/Ladder Yacht
- 05 Parabordo/Rubber fender

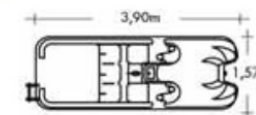

5 + = 375 kg WEIGHT 160 kg  
 MATERIAL: FIBERGLASS



# Optional



**01**  
Maniglie  
tieniti bene  
*Handle*



**02**  
Pulpito  
*Bow pulpit*



**03**  
Protezione chiglia  
*Keel protection*



**04**  
Scaletta  
standard  
*Standard  
Ladder*



**04/Y**  
Scaletta  
*Ladder Yacht*



**04/B**  
Scaletta  
*Ladder Basic*  
**04/E**  
Scaletta  
*Ladder Elite*



**05**  
Parabordo  
*Rubber fender*



**06**  
Ruote  
*Wheels*

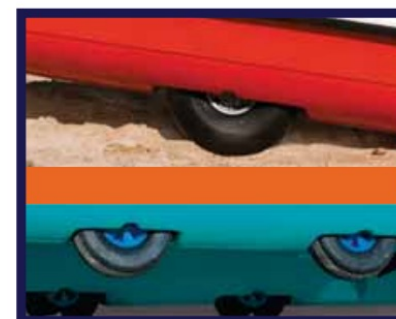

**06/J**  
Ruote  
*Wheels Jumbo*

**06/2**  
4 Ruote  
*4 Wheels*



# Optional



**07**  
Scivolo  
*Slider*



**08**  
Salvagente  
anulare  
*Life buoy*



**09**  
Tettuccio parasole  
*Sun&rain shield*



**10**  
Trampolino  
*Spring board*



**11**  
Buffer  
*Buffer*



**12/B**  
Scivolo  
*Big Slider*



**12/S**  
Scivolo  
*Slide Superslider*



**13**  
Scivolo  
*Bent Slider*



**15**  
Telo di rimessaggio  
*Textile coverage*



# ULISSE



Isola felice.  
Happy place.



### OPTIONAL

- 07 Scivolo/Slide
- 10 Trampolino/Spring board
- 11 Buffer

### DOTAZIONE DI SERIE STANDARD EQUIPMENT

- 04/B Scaletta/Ladder Basic
- 05 Parabordo/Rubber fender

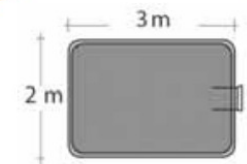
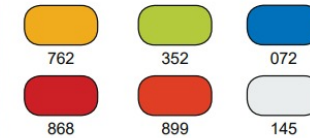

WEIGHT 150 kg - MATERIAL: FIBERGLASS

# VERSAILLES



Occhiello a poppa diametro 12/Ringbolt in the bow diameter 12  
 Scalmiera in ottone inossidabili/Oarlock of Stainless brass  
 Protezione chiglia a prua acciaio inox/Keel protection in the bow  
 4 corrimano in acciaio inox/4 stainless steel handrails  
 Panca reversibile per ripostiglio/Swinging bench for the boat storage

## VERSIONE A MOTORE

F.B. = 4,4 Kw (6Cv)

4 + = 320 kg

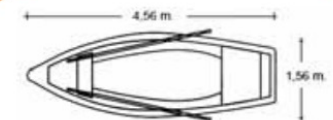

4 + = 320 kg WEIGHT 165 kg  
 CAT. C





**MARTINI**<sup>®</sup>  
*Costruzioni Nautiche*



# REDLIFE



Un pezzo unico  
*One of a kind*



È il primo pattino della MARTINI Costruzioni Nautiche, interamente costruito in vetroresina con rinforzi interni al braccio della scalmiera in mogano, per essere sempre più resistente e duraturo. Molto stabile, è ideale per le operazioni di soccorso e vigilanza anche in condizioni di mare critiche. Scalmiera in ottone e acciaio inox 316 (brevettata).

È dotato di serie di ruote d'alaggio incorporate negli scafi per partire da riva velocemente, di 2 salvagenti anulari, sagola galleggiante da 30 m, 1 mezzo marinaio, 1 salvagente Baywatch. Riserva di galleggiamento in polistirene più poliuretano espanso, 2 remi in legno, manicotto in nylon per la protezione del remo (brevettato).

REDLIFE is the first MARTINI rescue rowing catamaran entirely made of fiberglass with internal mahogany reinforcement in the sleeves of the rowlock support that makes it last longer. Very stable, it has been designed specifically for rescue operation even in critical sea conditions. It is equipped with patented rowlock in brass and stainless steel. Reserve buoyancy in polyurethane plus polystyrene foam. The incorporated haulage wheels make it easier to leave quickly the shore. Its standard equipment includes 2 ring life buoys plus 1 lifeguard rescue can, 30 m of floating rope, and one boat hook, 2 wooden oars with protective nylon muffs (patented).



868



145

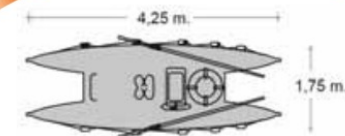



CE 2 + 1 + = 190 kg CAT. D

# BAYLIFE



*Dinamico, sicuro e veloce  
Dynamic, safe and fast*

 Dinamico e veloce per il soccorso in mare; la forma degli scafi a chiglia piatta lo rende molto stabile anche in condizioni di mare critico. Fornito di ruote d'alaggio incorporate negli scafi, per velocizzare le operazioni di soccorso. Equipaggiato di serie di n° 2 salvagenti Solas, cime di lancio, Baywatch e mezzo marinaio. Materiale di costruzione: n° 3 traverse di collegamento scafi in acciaio inox, scalmiera in ottone, scafi e coperta in vetroresina rinforzata, riserva di galleggiamento in polistirolo.

 Fast and dynamic for rescue operations. The flat keel of the hull makes it very stable, even under the most difficult sea conditions. It has haulage wheels incorporated in the hull to speed up rescue operations. It is also equipped with 2 Solas ring lifebuoys, launch cables, a rescue can and a boat hook. Construction material: 3 hull connection beams in stainless steel, brass rowlocks, hulls and deck in reinforced fiberglass and a polystyrene reserve buoyancy.

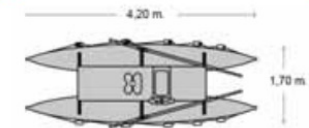

CE  +  +  = 190 kg CAT. D





# VIAREGGIO RESCUE



Mare mosso, nessun problema  
*Heavy seas, no problem*



 Ideato dal sig. Barsanti Mario, noto artigiano e maestro d'ascia con lunga esperienza di bagnino di salvataggio sulle coste della Versilia dove spesso si affrontano condizioni di mare mosso, con venti di Libeccio o Maestrale. Il pattino di salvataggio Viareggio Rescue è stato progettato per poter affrontare questi mari, per poter dare soccorso immediato ai bagnanti in pericolo. È fornito di ruote d'alaggio incorporate negli scafi, ciò permette di partire da riva velocemente. Equipaggiato di serie con nr. 2 salvagenti anulari, sagola galleggiante di 30 m, mezzo marinaio e salvagente Baywatch. Realizzato in vetroresina, traverse in acciaio inox, scalmi in ottone, portascalmi con innesto a baionetta che permette di bloccare o sganciare rapidamente il remo.

 Designed by Mario Barsanti, a famous boat-builder with a long experience as a lifeguard on the Versilia coast, where strong north-westerly or south-westerly winds can create very rough sea. Viareggio Rescue rescue boat has been developed to be used in rough sea conditions, to provide immediate help to people in danger in water. The boat has launching wheels built into the twin hulls, making it easier to leave quickly the shore. Standard equipment includes 2 ring lifebuoys, 30 m of floating lifeline, a boathook and 1 lifeguard rescue can. Made of fiberglass with stainless steel crosspieces. Brass rowlock and rowlock support with bayonet type attachment enabling the oar to be rapidly secured or released. Reserve buoyancy.





868

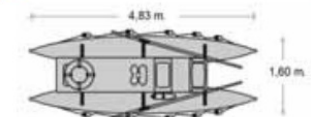

145



CE 3  +  = 240 kg CAT. D

# TORRETTA LIFEGUARD COLOMBO



Lunghezza 120 cm - Larghezza 120 cm  
 Altezza con tetto 440 cm  
 Altezza postazione 200 cm  
 Supporti aggiuntivi per interro: 60 cm

Completamente in acciaio inox con pannelli e tetto in vetroresina.

Completamente smontabile.

Possibilità di utilizzare i tre pannelli per sponsorizzazioni pubblicitarie.





# VIAREGGIO RELAX



Invito al relax  
*Invitation to relax*

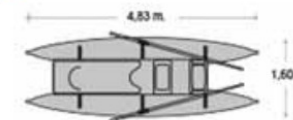

CE 3 + = 240 kg CAT. D

# PARADISE



Invito al relax  
*Invitation to relax*

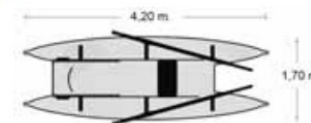
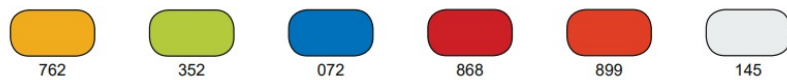

CE 2 + 1 + = 190 kg CAT. D

# BAYRELAX



L'essenza dell'estate  
*The essence of summer*

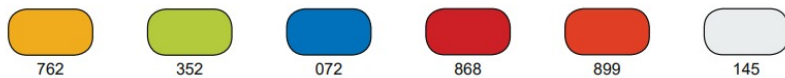

762

352

072

868

899

145

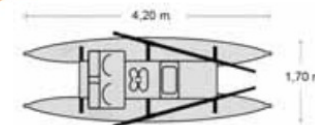

CE 2 + 1 + = 190 kg CAT. D





# GRETA



Comfort e stile  
Comfort and style



 La spiaggia Greta, ha un design essenziale, moderno ed elegante; ideale per piscine e per il mare. Permette di abbronzarsi sul bagnasciuga lambiti dalle onde nelle ore più calde e di proseguire l'abbronzatura in due posizioni di cui una con le gambe più in alto del tronco per migliorare la circolazione e per catturare anche gli ultimi raggi del sole della giornata. È indistruttibile, non teme la salsedine; maneggevole e leggera da portare; per l'alloggiamento invernale non avrà problemi di spazio: è sovrapponibile. Greta è costruita in polietilene lineare ad alta densità.

 With its essential, modern and elegant design, Greta is the ultimate sunbed for any swimming pool or for the sea. You can sunbathe lapped by sea waves enjoying even the hottest sun. One position allows you to keep your legs high, improving your circulation and catch even the latest sunrays of the day. Salt-water corrosion resistant, indestructible, handy and light to carry around. It can be stacked for an easy winter storage. Greta is manufactured in high-density, linear polyethylene.

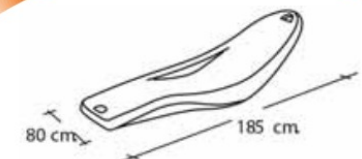

WEIGHT 14 kg - MATERIAL: POLYETHYLENE





# GRETA EVO



L'evoluzione di comfort e stile  
*The evolution of comfort and style*



 Ideale per prendere il sole, questa nuova spiaggia nasce dall'evoluzione della fortunata spiaggia Greta. È dedicata a chi non si accontenta, ancora più confortevole e stabile sia a riva e soprattutto nel galleggiamento in acqua dove si alza anche la linea di galleggiamento per un comfort davvero inimmaginabile grazie anche al suo disegno conformante al corpo.

 GRETA EVOLUTION is the evolution of our bestseller Greta. It is an ideal sunbed, even more comfortable and stable. It can be used on the shore and it is extra comfortable on water thanks to its improved floating capacity and its ergonomic shape.

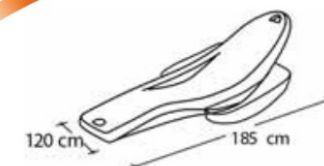
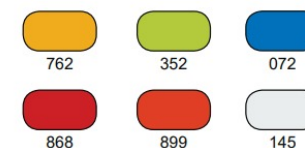

WEIGHT 18 kg - MATERIAL: POLYETHYLENE

# MALIBU



Non si gonfia più  
*Relax! No matter if alone ore all together*

 Malibu non si gonfia più, infatti è sempre pronto a regalare intense emozioni fatte di relax e divertimento.

Concepito per il noleggio, perciò pratico, leggero e con i suoi colori attira e si fa notare, solidamente galleggiante (fino a 120 kg). Gli utilizzatori possono addirittura agganciarsi insieme, con le apposite stringhe, per formare colorate piattaforme del divertimento in acqua. È l'attrazione dell'estate che non può mancare nei moderni centri balneari.

 Always ready for use, since it doesn't need to be inflated. With Malibu you can either have fun or relax. Ideally designed to be rented, eye – catching, handy and lightweight, Malibu can safely carry people weighing up to 120 kg. Moreover they can be hooked together using specific bands and form fun colorful platform on the water. Malibu is a must have for all the modern beach clubs and sea resorts.

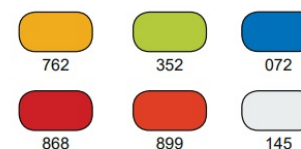

WEIGHT 14 kg - MATERIAL: POLYETHYLENE



# NIRVANA



SUP, il nuovo gusto dell'avventura per "surfare" o prendere il sole.  
*Ideal for leisure activities and sports*



 SUP, il nuovo gusto dell'avventura per "surfare" o prendere il sole.

Dotata di due compartimenti stagni e rete elastica. Ideale per il tempo libero e lo sport.

 Ideal for leisure activities and sport. It is equipped with two watertight storage compartments and an elastic net. Ideal for leisure activities and sports.

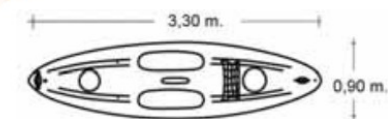

WEIGHT 22 kg - MATERIAL: POLYETHYLENE

# AKITA



Divertirsi da soli o in compagnia  
*Having fun on your own or with friends*

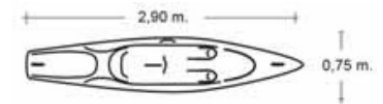
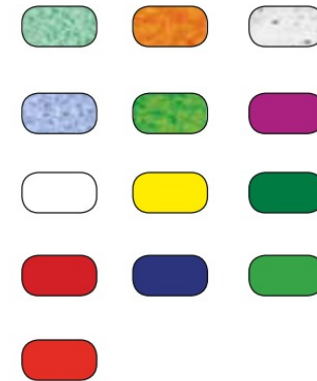

COCKPIT 120 x 48 - WEIGHT 20 kg  
MATERIAL: POLYETHYLENE

# AKITA DOUBLE



Divertirsi da soli o in compagnia  
*Having fun on your own or with friends*

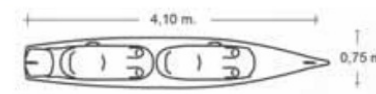
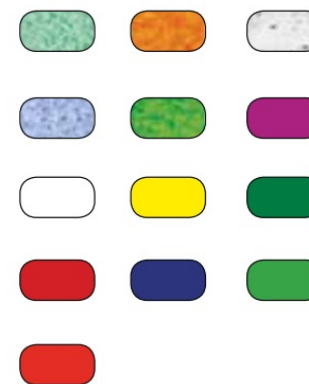

COCKPIT 120 x 48 - WEIGHT 28 kg  
MATERIAL: POLYETHYLENE

# PEGASO K1

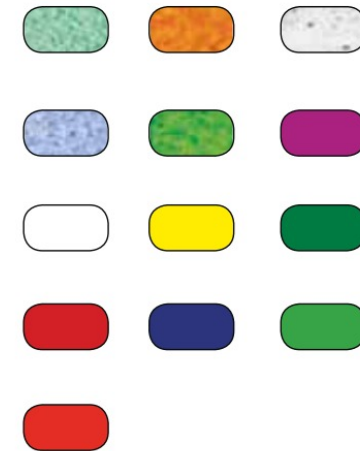

Per lunghe escursioni  
*For long watertrips*

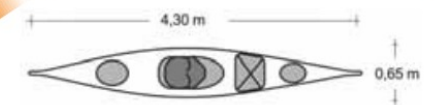

COCKPIT 86 x 48 - VOLUME 3701  
WEIGHT 20 kg - MATERIAL: POLYETHYLENE

# MOOREA 1



Divertimento per tutta la famiglia  
*Fun for the whole family*

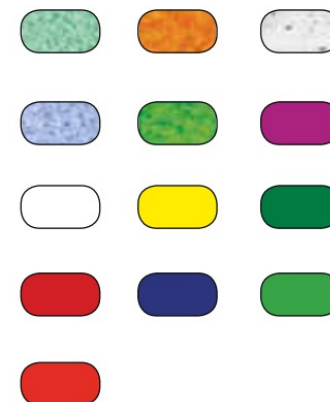

\*OPTIONAL

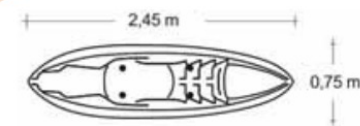

WEIGHT 23 kg - MATERIAL: POLYETHYLENE



# MOOREA 123

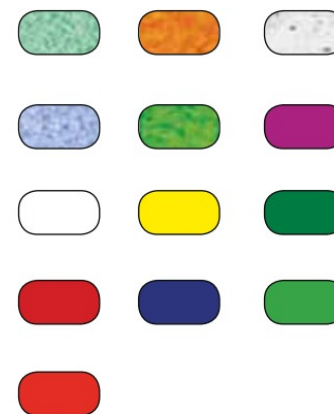

Divertimento per tutta la famiglia  
*Fun for the whole family*

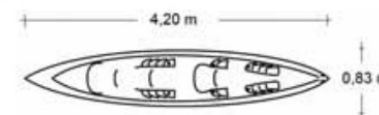

WEIGHT 34 kg - MATERIAL: POLYETHYLENE

# Accessori Canoe e Rescue



**C13**



**C14**



**C15**



**C16**



**C17**



**C18**

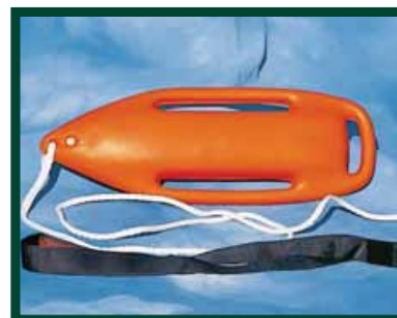

**C19**



**C20**



**C21**



**C22**

# PEDAL BOATS SPARE PARTS

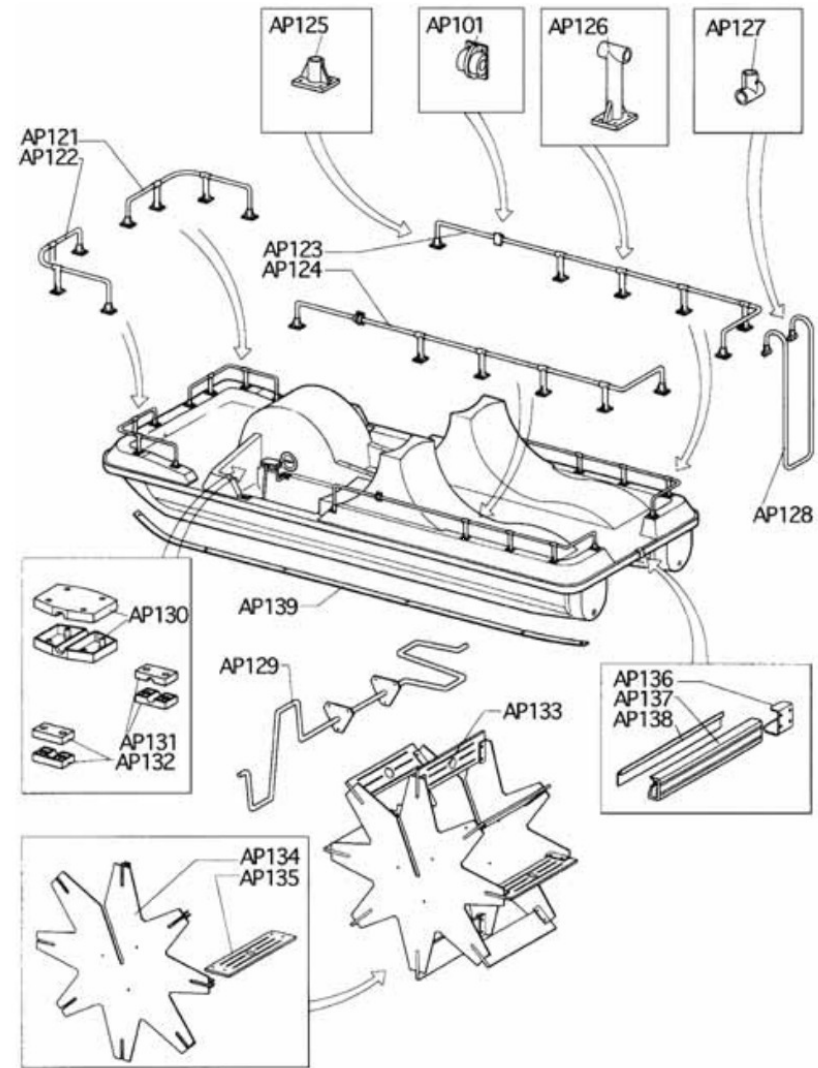
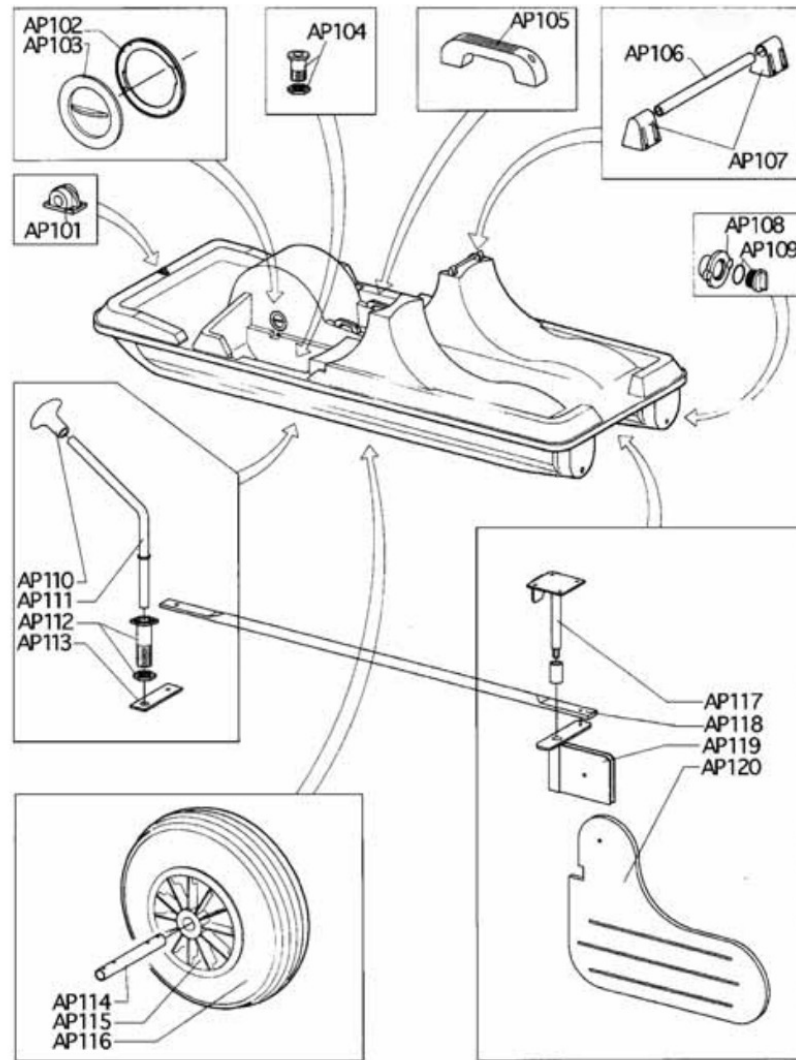

# Colori per polietilene / Colors for polyethylene





## Colori per fibra di vetro/*Colors for fiberglass*

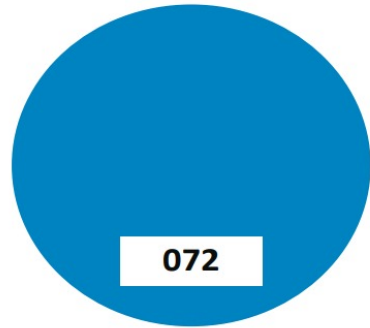

072

**RAL 5012**

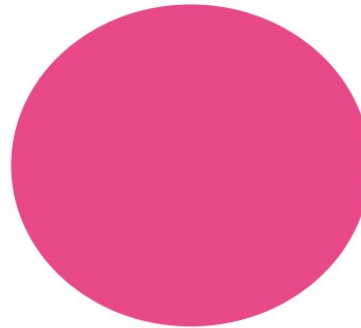

**RAL 4003**

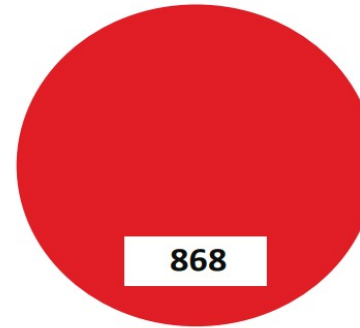

868

**RAL 3020**

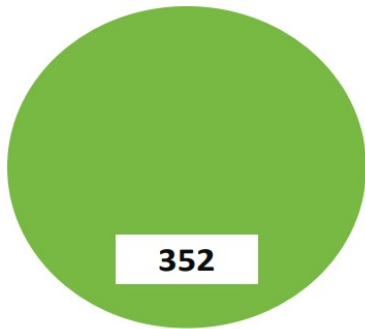

352

**PANTONE 375 C**

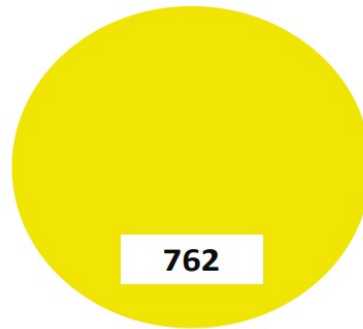

762

**RAL 1018**

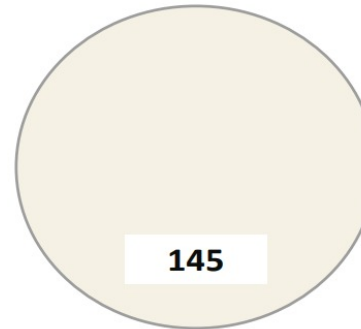

145

**RAL 9010**

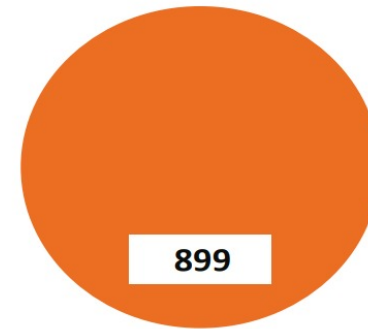

899

**RAL 2004**

# DISTRIBUTORS

FOLLOW US:



## ITALIA

### **MARTINI Costruzioni Nautiche s.r.l.**

Via Tarcento, 130  
47522 S. Giorgio di Cesena (FC)  
Tel. 0547 325121 - Fax 0547 325316  
www.martininautica.com  
info@martininautica.com

## **CZECH REPUBLIC & POLAND**

### **CAMP s.r.o.**

Kancelár Valcharská, 39 614 00 Brno  
Tel. +420 545 241 377 - Fax +420 545 241 378  
Mob. +420 608 233 344  
e-mail: camp.vyr@seznam.cz

## **GREECE**

### **AQUACENTER Sideris Miros**

28 Stefanogiorgi Str. - 71202 Heraklion Crete  
Tel. +30 2810 372992 - Fax +30 2810 372993  
Mob. +30 6945 298 382  
e-mail: info@aquacenter.gr  
www.aquacenter.gr

## WORLD

### **AUSTRIA - SOUTH GERMANY GEHR-BOOTE**

Fischerstrand, 21 - 1220 Wien  
Tel. +43 (0)1 2690741 - Fax +43 (0)1  
269074110  
e-mail: office@gehrboote.at  
www.gehrboote.at

## **FRANCE**

### **PROFIL NATURE**

Moulin de Rollequin - 02130 Fère en Tardenois  
www.profilnature.com  
e-mail: contact@profilnature.com  
Tel. +33 3-23-82-61-13

## **ROMANIA**

### **S.C. PRATO IMPEX Srl.**

Calea Serban Vodă, Nr. 139 - Corp A  
Sector 4, 040213 Bucuresti - Romania  
Tel/Fax +40 21 33 70 462 - Mob. +40 744 50 23 02  
e-mail: cezarpalii@gmail.com  
www.pronautic.ro

## **HRVATSKA E SLOVENIJA**

### **AREA MARIS d.o.o.**

Trg Kralja Tomislava, 7 - 52100 Pula  
Tel. +385 52 382 393 - Fax +385 52 382 394  
e-mail: info@areamaris.hr  
www.areamaris.hr

## **NORTH GERMANY**

### **BOOTE-KEUSEN**

Sielbecker Landstraße, 17 - 23701 Eutin-Fissau  
Tel. +49 (0)4521 4201 - Fax +49 (0)4521 78032  
e-mail: t.keusen@bootekeusen.de  
www.boote-keusen.de

## **SWITZERLAND**

### **KATAMARAN SPORT Renè Meier**

Bergstrasse, 27 - 8618 Oetwil  
Tel. +41 (0)44 7991996 - Fax +41 (0)44 7991997

## **CUBA**

### **GAMMA EXPORT S.r.l.**

Via G. Watt, 37 - 20143 Milano  
Tel. +39 (0)2 89150018 - Fax +39 (0)2  
89155377  
Mob. +39 89 128985

## **SWEDEN**

### **WHEELWAY HB**

Lorsände, 3 - 57399 - Tranås  
Tel. +46 140 52007 / +46 070 3693408  
e-mail: info@wheelway.se  
www.wheelway.se



# INDICE

SUNNY H20.....	pag. 8	ULISSE.....	pag. 35
SUNNY H20 PLUS.....	pag. 9	VERSAILLES .....	pag. 36
SUNNY H20 SMART .....	pag. 10	REDLIFE.....	pag. 39
JOLIE .....	pag. 11	BAYLIFE .....	pag. 40
SUNNY TIME 4 .....	pag. 12	VIAREGGIO RESCUE .....	pag. 41
HAPPY HOUR .....	pag. 13	TORRETTA LIFEGUARD COLOMBO .....	pag. 42
SUNNY TIME S .....	pag. 14	VIAREGGIO RELAX .....	pag. 44
SEABUGGY 405 .....	pag. 15	PARADISE .....	pag. 45
SEABUGGY 330 .....	pag. 16	BAYRELAX .....	pag. 46
CIGNO.....	pag. 17	GRETA.....	pag. 48
FLAMINGO.....	pag. 18	GRETA EVO .....	pag. 49
UNICORNO .....	pag. 19	MALIBU .....	pag. 50
ANATRA .....	pag. 20	NIRVANA.....	pag. 52
SUNNYTIME 330.....	pag. 21	AKITA .....	pag. 53
SUNNY MOUSE.....	pag. 22	AKITA DOUBLE .....	pag. 54
SUNNY R .....	pag. 23	PEGASO K1 .....	pag. 55
SUNNY R COMFORT.....	pag. 24	MOOREA 1.....	pag. 56
SUNNY TIME .....	pag. 25	MOOREA 123.....	pag. 57
SUNNY TIME SPECIAL .....	pag. 26	ACCESSORI CANOE E RESCUE .....	pag. 58
SUNNY SPEEDY 4 .....	pag. 27	PEDAL BOATS SPARE PARTS .....	pag. 59
SUNNY SPEEDY .....	pag. 28	COLORI PER POLIETILENE .....	pag. 60
SUNNY SPEEDY + MANOLO' .....	pag. 29	COLORI PER FIBRA DI VETRO .....	pag. 61
PAGURO.....	pag. 30	DISTRIBUTORS .....	pag. 62
OPTIONAL.....	pag. 32-33		



**MARTINI**<sup>®</sup>  
*Costruzioni Nautiche*



**MARTINI Costruzioni Nautiche s.r.l.**  
Via Tarcento, 130 - 47522 S. Giorgio di Cesena (FC)  
Tel. 0547 325121  
[www.martininautica.com](http://www.martininautica.com)  
[info@martininautica.com](mailto:info@martininautica.com)